

roveramp

HiBOOST Boost Your Bars

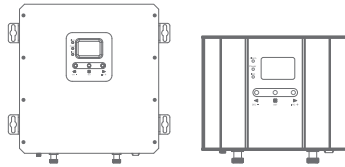

User Manual

Industrial 50K

Mobile Signal Booster



CONTENT

WHAT'S INCLUDED	3
HOW IT WORKS	3
HOW TO INSTALL YOUR SIGNAL BOOSTER	3
1.1 Overview	3
1.2 Installation Preparation	4
1.3 How to find the location with the strongest received signal	5
1.4 Install Outdoor Antenna	6
1.5 Install Indoor Antenna	7
1.6 Install Signal Booster	8
1.7 Run coaxial cable	9
1.8 Power up your the Signal Booster	9
SIGNAL BOOSTER STATUS	9
LCD Features	10
ALC and ISO Status	11
LED Status	12
Control Buttons Operation and Manual gain control (MGC)	12
TROUBLESHOOTING	14
FCC RF Exposure Statement	15
IC RF Exposure Statement	15
Warnings	15
SPECIFICATIONS	17
PRODUCT WARRANTY	18

WHAT IS INCLUDED



Industrial 50K



12V/3A
AC/DC Power Supply



Booster Mount
Hardware

We provide all accessories needed for the signal booster. For more information please visit [www.hiboost.com](#)

Warning: Unauthorized antennas, cables, and/or coupling devices are prohibited by new FCC rules.

HOW IT WORKS

The HiBoost Industrial 50K signal booster is designed to help mobile users improve signal for large commercial and industrial sites and other areas where cellular signal is weak or unreliable. The outdoor antenna receives the signal from the nearest cellular tower, amplifies it, and transmits to the signal booster. Then the indoor antenna will receive the signal and retransmit it to your mobile device. The signals produced by your phone are also amplified by the indoor antenna via the booster and outdoor antenna.

This manual provides simple installation instructions.

HOW TO INSTALL YOUR SIGNAL BOOSTER

1.1 Overview

This manual will help you properly install your signal booster. It is important to read through all of the installation steps before installing your equipment. Thoroughly read through the instructions, visualize where all the equipment will need to be installed and do a soft installation by placing the devices where they need to be before mounting any equipment.

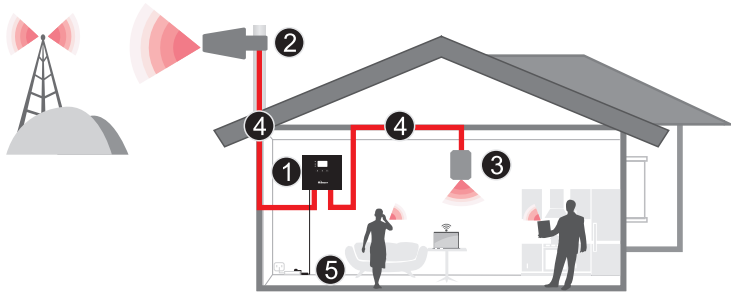

- 1 Industrial 50K Signal Booster
- 3 Indoor Antenna
- 5 12V/3A, AC/DC Power Supply

- 2 Outdoor Antenna
- 4 Cable

1.2 Installation Preparation

Before you install

- Make sure you have sufficient cable length between the proposed outdoor/indoor antenna location and booster connector.
- Make sure the position you install the booster is near to an existing electrical outlet, well ventilated, and away from excessive heat, moisture, and direct sunlight.

Tools Required



Phillips Screwdriver



Drill



Mobile Phone

Before you get started, you will need to plan the layout of your system. This involves finding the location with the strongest received signal from the cellular tower, as well as antenna, booster, and cable placement.

General installation steps:

1. Find the strongest received signal for the location of the outdoor antenna.
2. Install the outdoor antenna on the roof to obtain the strongest downlink

signal from the local cellular towers. It should also be as far away as possible from where you plan to place the indoor antenna (vertical separation is more important than horizontal separation).

3. Install the indoor antennas where you want to improve the signal level.
4. Mount the booster, connect the cables from the outdoor antenna and indoor antenna at the designated ports, and connect the booster to the AC supply (make sure all the cables are connected before applying power).

1.3 How to find the location with the strongest received signal

The outdoor signal strength the booster receives directly affects the efficiency of the indoor coverage. That is why it is crucially important to install the antenna at a good location and point it properly towards a tower where signal reception is the strongest.

There are many methods that can be used to find the strongest signal from the cellular towers. One is to use the LCD display on the booster that shows the downlink power output of the booster in each band, the other is to use a mobile phone or mobile phone app to test signal strength, and the third is to use a commercially available signal strength meter.

We highly recommend that you use the LCD display on the booster as this method is generally more convenient. However, in situations where the desired carrier's signal is much weaker than the other local signals, using a mobile phone, app or signal level meter can be a more accurate method of homing in on the best signal for installation.

• LCD Display Method

Connect the outdoor antenna to the booster's outdoor port. Fix the outdoor antenna on the roof of the building and point it to the nearest cell tower. Then have a look at the gain and output power value displayed on the booster's LCD.

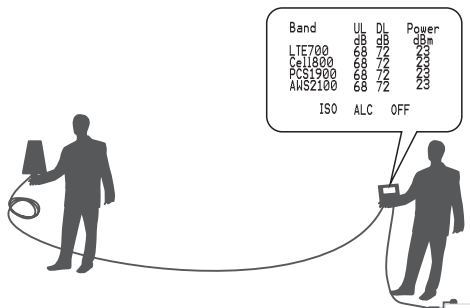

The outdoor antenna receives the strongest signal when the booster's downlink output power reaches its highest level in each band. If the LCD shows maximum



gain and power, and there are not any alarms (no ISO, ALC, OFF legend flashing and no quick flashing green or red in LEDs), it means the present location is the best for ensuring that the booster has maximized performance. The maximum downlink power for Industrial 50K is 23dBm, and the maximum downlink gain is 72dB.

Note: These showed values may vary dynamically at times between 1-3 dB which is normal due to outdoor signal conditions.

• Mobile Phone Method

You can use a telephone to test signal strength on the top of the building. The number of bars on the network indicator will define approximate strength of the received signal. Normally the roof of the building is the best place to receive the strongest signal. As shown on the drawing below, you need to test the signal in the points from A to E, and select the location with the best signal strength for outdoor installation. It is recommended to use a mobile app that can display in a test mode the signal level in dBm units. It is more accurate than checking the signal bars. For more details refer to <http://blog.hiboostusa.com/signal-strength-measure-instructions/>.

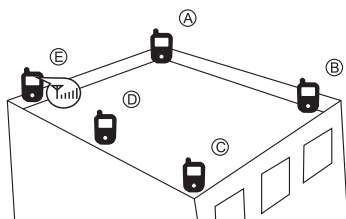

Note: Please try to receive a signal from cell towers that are not overloaded with multiple users. This can be estimated by the population density in the area served by the tower. For example, it is recommended to avoid cell towers near supermarkets, shopping malls, stadiums or any other public places visited by many people regularly. This will help maintain reliable phone call connections and higher speed data services.

Mark the strongest received signal as the installation location and direction for the outdoor antenna.

1.4 Install Outdoor Antenna

Install the outdoor antenna at the the location with the strongest received signal.

IMPORTANT: Testing the signal 3 times in the desired location before installing the outdoor antenna will help ensure the most smooth and stable phone calls and data transmission.

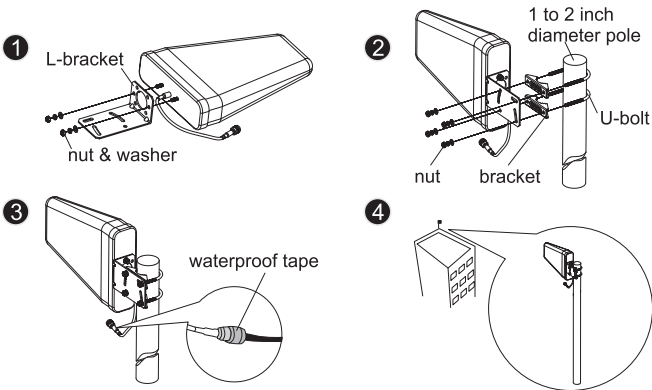

Outdoor wide band directional antenna installation for reference

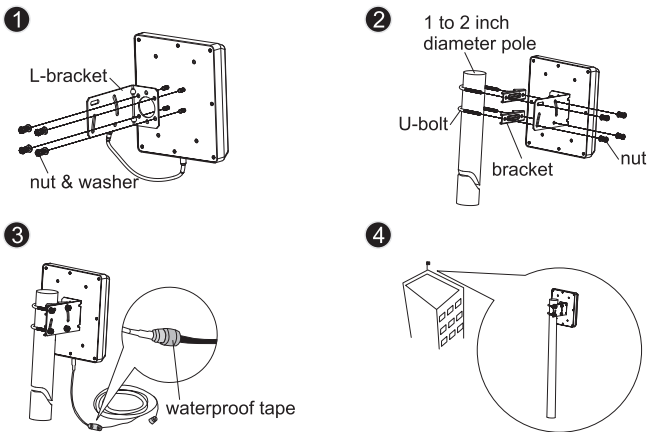

Outdoor wide band panel antenna installation for reference

Note: Be sure the cradle is at the desired height and rotated toward the strongest cellular signal before tightening the nuts. Do not over tighten.

1.5 Install Indoor Antenna

Select a place on a wall in the area where you need better reception. Mount the indoor antenna with the included screws as shown in the figure below.

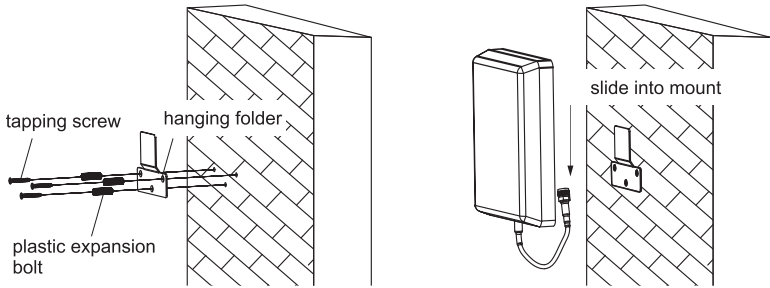

Indoor wide band panel antenna installation for reference

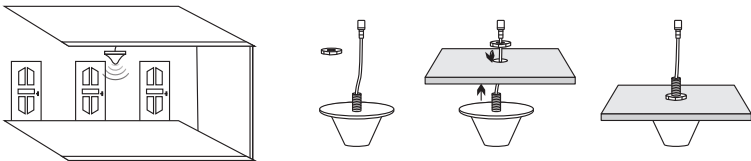

Indoor wide band dome antenna installation for reference

1.6 Install your signal booster

The signal booster should be mounted in an easily accessible area so it's easy to perform general maintenance. The area is properly ventilated and not exposed to excessive heat, moisture and/or direct sunlight. The optimal area would be on a wall located near a power outlet. Please use a surge protector rated at a minimum of 1000 Joules between the booster's power adaptor and the AC power outlet on the wall.

Mount the booster with the included screws as shown in the figure below.

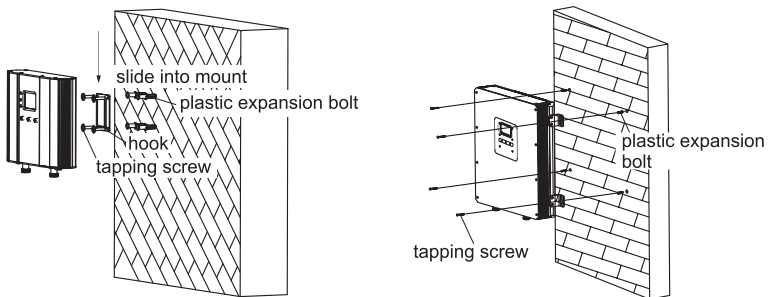

1.7 Run coaxial cable

Loosely run the supplied coaxial cable from your outdoor antenna to your booster connector marked "Outdoor". We recommend applying waterproof tape to fully waterproof the connection.

Connect the indoor antenna cables from your indoor antenna to the booster connector marked "Indoor". Tighten the connection by hand.

(After you have tested the system you can permanently secure the coaxial cable).

As you route and pull cabling, follow these general guidelines:

- Bend cables and route them smoothly, and protect the outer skin against any damage.
- Keep horizontal cables straight and fasten them with a tie every three to five feet.
- Bind and fasten vertical cables every six to eight feet.
- Waterproof all connectors between outdoor antenna and coaxial cables with waterproof tape to avoid water or other kinds of damage.
- Be careful when plugging the connector in so as not to damage the center pins on the connectors.

1.8 Power up your signal booster

Once all the following precautions have been taken, power on the signal booster.

1. Verify that you have left at least 20 feet of vertical separation space between the indoor and outdoor antennas.
2. Never point the front of outdoor antenna towards the inside of the indoor antenna.
3. Verify that the supplied coaxial cables from both the outdoor antenna and the indoor antenna are properly connected to the signal booster before powering it up.
4. Carefully plug in the supplied power adaptor into the signal booster where it is marked 'DC 12V' and connect the other end to a power outlet.

The LED indicator marked power should light up green.

SIGNAL BOOSTER STATUS

Overview: The booster has a smart startup system. When you have finished the booster system installation and power on the booster, it will start its initialization process to check the received downlink signal from the cell site and the isolation status. This an automatic process designed to ensure its best performance. This will take approximately 3-5 seconds.

After the booster starts up, please check if the coverage is good. If it is good, the booster system installation is complete. If the coverage is not adequate, please



fully reread and understand the LCD, LED indications, control buttons and MGC function on your booster, as they will help you identify and solve any potential issues.

• **LCD Features**

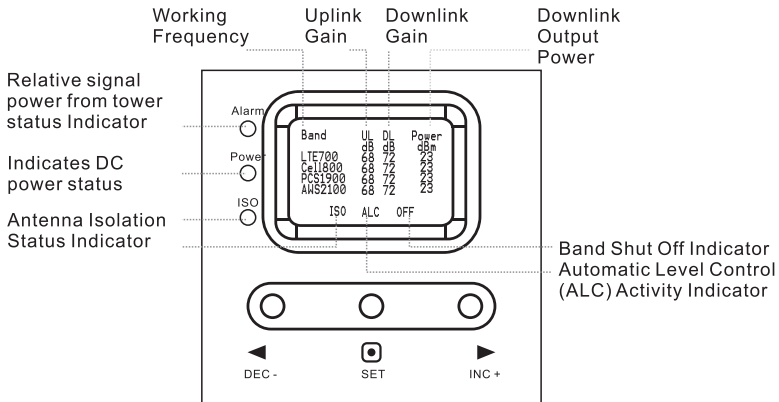

Band: Shows the working frequency bands where the booster is operating.

UL/DL: Shows real-time uplink and downlink gain(dB). These values will change slightly as the ALC or ISO makes changes to the gain to optimize coverage.

Power: Shows real-time downlink power(dBm) that the booster is delivering to the indoor antenna port. When the booster DL output power is lower than -10dBm, the value will display "---".

ISO: When the system does not have enough isolation between the outdoor and indoor antennas, the "ISO" indicator will be flashing showing that the ISO has lowered the gain in some bands to keep the system from oscillating. Press the "SET" key and the LCD screen will turn on to help with troubleshooting and display "ISO" value showing the current band or bands affected.

ALC: When the booster is receiving too much DL power from the tower and the DL booster output is close to saturating, the "ALC" indicators will flash showing that the ALC has lowered the gain to prevent this overload condition. Press the "SET" button and the screen will turn on to help with troubleshooting and show the band or bands affected.

OFF: In some rare situations the ALC or ISO will not be able to compensate for an oscillation condition or a downlink overload. When this happens the booster will shut off in the affected band and the LCD “OFF” indicator will flash. Pressing the “SET” button will turn on to help with troubleshooting and display which band or bands are affected.

ISO flash		
Band	UL	DL
LTE700	---	2
Cell1800	---	3
PCS1900	---	---
AWS2100	---	---

ALC flash		
Band	UL	DL
LTE700	---	2
Cell1800	---	3
PCS1900	---	2
AWS2100	---	---

OFF flash		
Band	UL	DL
LTE700	---	---
Cell1800	---	---
PCS1900	OFF	OFF
AWS2100	OFF	OFF

• ALC and ISO Status

LCD	Status	Definition	
ALC legend	No Flashing	Output power is not maximum.	Check coverage, leave as is if it's good; if the coverage is poor, please check the Troubleshooting section to get solutions.
	ALC < 10	Full output power.	
	ALC ≥ 10	Output power is too high.	Not working properly. Please check the Troubleshooting section to get solutions.
	ALC ≥ 31	The booster automatically shuts off for protection from excessive downlink signal from tower.	
ISO legend	No Flashing	No loopback or no self-oscillation. Working properly.	
	ISO < 10	Slight loop back or self-oscillation.	
	ISO ≥ 10	Deep loop back or self-oscillation.	Not working properly. Please check the Troubleshooting section to get solutions.
	ISO ≥ 22	The booster automatically shuts off for protection due to very severe self-oscillation.	



• LED Status

LED	Status	Definition	
Power LED	Green	Normal	
	Off	DC power problem	
Alarm LED	Green	Output power is not maximum.	Check coverage, leave as is if it's good; if the coverage is poor, please check the Troubleshooting section to get solutions.
	Slow Flashing Green	Full output power.	
	Quick Flashing Green	Output power is too high.	Not working properly. Please check the Troubleshooting section to get solutions.
	Quick Flashing Red	The booster automatically shuts off for protection from excessive downlink signal from tower.	
ISO LED	Green	No loopback or no self-oscillation. Working properly.	
	Slow Flashing Green	Slight loop back or self-oscillation.	
	Quick Flashing Green	Deep loop back or self-oscillation.	Not working properly. Please check the Troubleshooting section to get solutions.
	Quick Flashing Red	The booster automatically shuts off for protection due to very severe self-oscillation.	

Control Buttons Operation and Manual gain control (MGC)

There are 5 operation modes relative to the control keys:

- Press the "SET" key for more than 3 seconds
- Short press on the "SET" key
- Short press on the "DEC-" key
- Short press on "INC+" key
- Simultaneously press on the "DEC-" and "INC+" keys for more than 3 seconds

Since the booster has a self-adaptive smart automatic level control (ALC) and isolation gain processing (ISO), most of the time manual adjustments are not required to achieve good coverage. However, in some cases where the ALC or ISO is working at a very high rate to adjust the gain and the Alarm or ISO LED is flashing more than once a second, a manual adjustment might be desired.

When the LCD is in the fixed display mode, press the “SET” key for more than 3 seconds. It will go into the “Gain Setting Mode” and make one of the gain values start to blink.

- Briefly press “SET” key, and the LCD will switch to the next gain value and it will start to blink. (Uplink or downlink gain for a different band).
- Press “INC+” key once shortly and the gain will increase by 1dB, Press “DEC-” once shortly and the gain value will be reduced by 1dB.
- Press the “SET” key for more than 3 seconds, and the LCD will return to the fixed display mode.

Band	Actual Gain display		MGC Setting Gain		PI/R
	UL	DL	UL	DL	
700	68	72	68	70	21
800	68	72	68	71	22
1900	68	72	68	72	23
2100	68	72	68	72	23

Actual Power display

Note: When adjusting the gain manually, please ensure that the uplink gain is equal to or not 5 dB less than the downlink gain setting. This avoids interference with the local cell site tower network.

When the LCD is in the fixed display mode, press the “DEC-” and “INC+” key simultaneously for more than 3 seconds, the booster will reset the gain to the default manufacturer settings.

When the LCD is in the alarm display mode, press the “SET” key and the LCD screen will turn on to help with troubleshooting and display the alarm indication showing the affected band or bands, press the “INC+” (or “DEC-”) key will switch to different pages.

If none of the keys are pushed within 30 seconds, the display will return to the fixed display mode. If none of the control keys are pushed within 5 minutes, the LCD screen will turn off. Pressing any key will return the display to the fixed mode.



TROUBLESHOOTING

Eliminate Flashing ISO legend and Quick Flashing Green, Quick Flashing Red ISO LED problems:

1. Adjust the outdoor antenna direction, keeping it away from indoor antenna. Restart booster.
2. Increase the vertical or horizontal distance between the outdoor antenna and indoor antenna. Restart booster.
3. Use barriers such as walls to increase the isolation.
4. Change the indoor antenna type to an antenna with a more directional antenna pattern. Orient the indoor antenna and outdoor antenna so they point in opposite directions.
5. Reduce the booster's downlink gain using the manual gain controls. Keep the uplink gain value and downlink gain value the same then restart the booster.

Note: Uplink gain must be equal to or not less than 5dB below the downlink gain, to avoid interference with the local carrier's cell site network.

Target: The ISO issues are solved when the ISO LED is "Green" or "Slow Flashing Green" or no flashing ISO legend.

Eliminate Flashing ALC legend and Quick Flashing Green, Quick Flashing Red Alarm LED problems:

1. Adjust the antennas' directions or locations to lower downlink received signal level.
2. Slowly reduce the downlink gain using the Manual Gain Controls.
3. If the above methods don't work, reduce the booster's gain with an external attenuator in line with the outdoor antenna or replace with lower gain antenna.

Target: The overload issues are fixed when the Alarm LED is "Green" or "Slow Flashing Green" or no flashing ALC legend. Please note that a "Green" LED indication may result in smaller coverage area. This can be improved by adjusting the outdoor antenna to receive a stronger signal.

Eliminate poor coverage problems when Power "----" legend or no flashing ALC Legend on LCD and Alarm LED is Green:

1. If the signal has not been improved, please check below:
 - The weak downlink signal leads to the low output signal level. Change the direction or position of the outdoor antenna. You may also try replacing the outdoor antenna with a higher gain antenna to increase the incoming signal.
 - Check to see if it is necessary to add more indoor antennas. Barriers such as walls can block the signal indoors. You should also check the booster to make sure the power is maximized. Try installing more indoor antennas or replace the booster with a higher powered one.
2. If the signal in a small section of the building hasn't been improved, try the

following:

- Check to see if the indoor antenna is installed correctly. Try moving the antenna to improve coverage.
- Try adjusting the direction the indoor antenna is pointing.
- Check whether it is necessary to add one or more antennas to enhance the coverage of special areas.

FCC RF Exposure Statement

This equipment complies with FCC radiation exposure limits set forth for an uncontrolled environment. This equipment should be installed and operated with minimum distance 30cm between the radiator and your body.

This transmitter must not be co-located or operating in conjunction with any other antenna or transmitter.

IC RF Exposure Statement

The device is compliance with RF exposure limits. The minimum distance from body to use the device is 20 CM.

Le présent appareil est conforme aux normes de conformité ou aux limites d'intensité de champ RF. La distance minimale du corps à utiliser le dispositif est de 20 CM.

Notice: The Manufacturer's rated output power of this equipment is for single carrier operation. For situations when multiple carrier signals are present, the rating would have to be reduced by 3.5dB, especially where the output signal is re-radiated and can cause interference to adjacent band users. This power reduction is to be by means of input power or gain reduction and not by an attenuator at the output of the device.

La puissance de sortie nominale indiquée par le fabricant pour cet appareil concerne son fonctionnement avec porteuse unique. Pour des appareils avec porteuses multiples, on doit réduire la valeur nominale de 3,5 dB, surtout si le signal de sortie est retransmis et qu'il peut causer du brouillage aux utilisateurs de bandes adjacentes. Une telle réduction doit porter sur la puissance d'entrée ou sur le gain, et ne doit pas se faire au moyen d'un atténuateur raccordé à la sortie du dispositif.

Warnings

Users must follow the below principles:



Booster should follow system requirement of communication equipment, assure good grounding and lightning protection.



The power supply voltage of booster should meet the standards of security requirement; any operation shall be carried out only after cutting off power in



advance. Only the professional is authorized for the operation.



Do not dismantle machine, maintain or displace accessories by yourself, because in this way, the equipment may be damaged and you may even get an electric shock.



Do not open the booster, touch the module of booster, or open the cover of module to touch the electronic component. The components will be damaged due to electrostatic.



Please keep away from heating-equipment, because the booster will dissipate heat during working. And do not cover booster with anything that influences heat-dissipation.

WARNING: This is **NOT** a **CONSUMER** device. It is designed for installation by **FCC LICENSEES** and **QUALIFIED INSTALLERS**. You **MUST** have an **FCC LICENSE** or express consent of an FCC Licensee to operate this device. Unauthorized use may result in significant forfeiture penalties, including penalties in excess of \$100,000 for each continuing violation.

Notice: When this device operating in the 1710~1755MHz band, the maximum antenna should be fixed height of 10 meters above ground. To meet FCC EIRP limit, the of antenna used with this amplifier must be offset by cable loss.

Any changes or modifications not expressly approved by the party responsible for compliance could void the user's authority to operate the equipment. This device complies with part 15 of the FCC Rules. Operation is subject to the following two conditions: (1) This device may not cause harmful interference, and (2) this device must accept any interference received, including interference that may cause undesired operation.

SPECIFICATION

RF Parameter	Uplink	Downlink	
Frequency Range	700MHz Band 12/17	698~716 MHz	728~746 MHz
	700MHz Band 13	776~787 MHz	746~757 MHz
	800MHz Band 5	824~849 MHz	869~894 MHz
	PCS1900 Band 25/2	1850~1915 MHz	1930~1995 MHz
	AWS2100 Band 4	1710~1755 MHz	2110~2155 MHz
Band width	700MHz Band 12/17	18 MHz	
	700MHz Band 13	11 MHz	
	800MHz Band 5	25 MHz	
	PCS1900 Band 25/2	65 MHz	
	AWS2100 Band 4	45 MHz	
Max. Gain	68 dB	72 dB	
Max. output power	17~24 dBm	23 dBm	
MGC (Step Attenuation)	≥ 25 dB / 1 dB step		
Electrical Parameter	Standard		
Power Supply	Input AC 100~240 V, 50~60 Hz, Output DC 12 V / 3 A		
Input & Output Impedance	50 ohm		
Mechanical Parameter	Standard		
I/O Port	N-Female		
Dimensions	8.6*6.5*2 inch / 218*165*50 mm 11*11.8*2.1 inch /280*300*53 mm		
Weight	≤ 5.0 lbs / 2.2 kg ≤ 11 lbs / 5 kg		



PRODUCT WARRANTY

30-Day Money-Back: All HiBoost products are protected by a 30-day money-back guarantee. If for any reason the performance of any product is not acceptable, the product may be returned to the reseller with a dated proof of purchase.

3-Year Warranty HiBoost Signal Boosters and kits are warranted for 3 years. Customers can choose to return the Signal Boosters and kits directly to the manufacturer at the purchaser's expense with a dated proof of purchase and a Returned Material Authorization (RMA) number supplied by HiBoost.

HiBoost will supply two options: repair or replace. HiBoost will cover the cost of delivery for the consumers located within the continental U.S.

This warranty does not apply to any Signal Boosters or kits determined by HiBoost to have been subjected to misuse, abuse, neglect, or mishandling that alters or damages physical or electronic properties. Failure to use a surge protected AC Power Strip with at least a 1000 Joule rating will void your warranty. Damage caused by lightning is not covered by this warranty.

All HiBoost products that are packaged with other HiBoost accessory products are intended for resale and used as a single integrated system. Such product kits are required to be sold to the end users or subsequent reseller as packaged.

The logo for Roveramp features the word "roveramp" in a lowercase, rounded, blue font. The letter "p" is white with three curved lines trailing off to the right, suggesting motion or a ramp. The background consists of three overlapping, angular shapes: a light gray triangle at the top, a red triangle in the middle, and a dark gray triangle at the bottom.

roveramp

<http://www.roveramp.com> | sales@roverholdings.com